

SAGA-EPOCALE
FULLBODY
COLLECTION
2020

URBANE
TILE • STONE

SAGA-EPOCALE

URBANE
TILE + STONE



7 SIZES

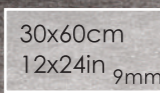
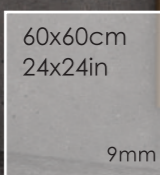
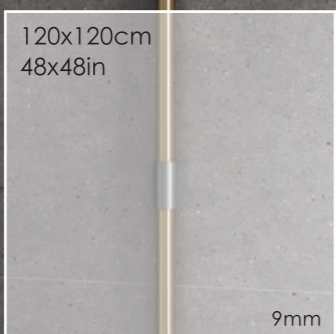

SAGA-EPOCALE COLLECTION

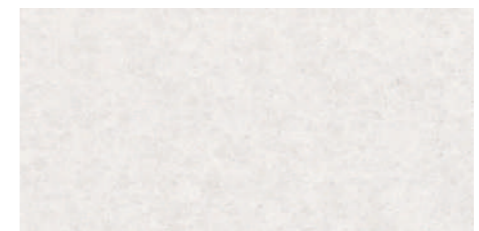
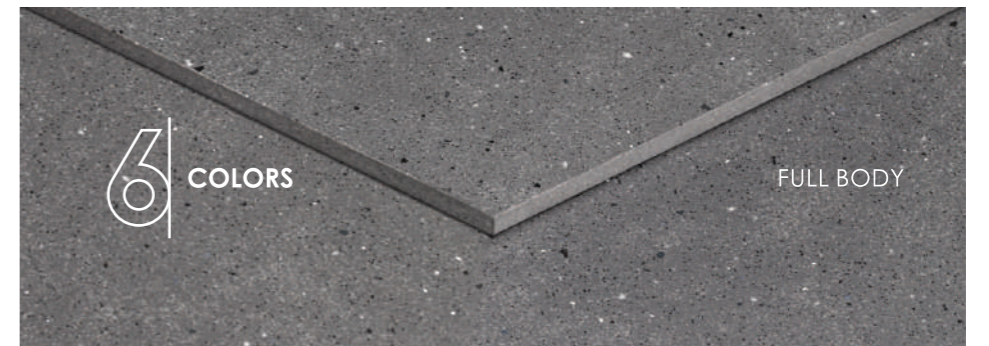

SAGA WHITE

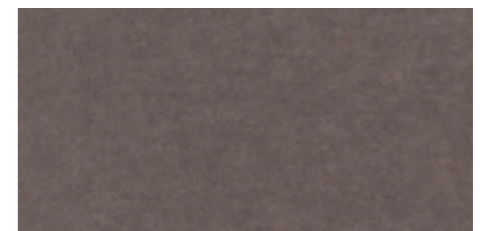

SAGA COCOA

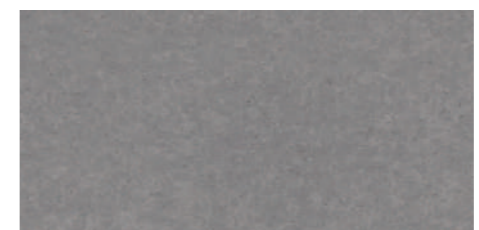

SAGA GREY

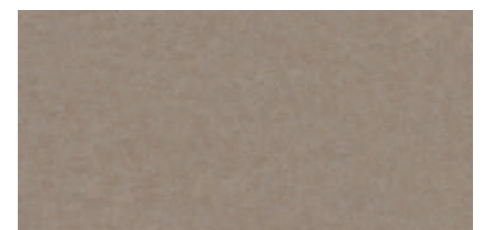

SAGA BARLEY

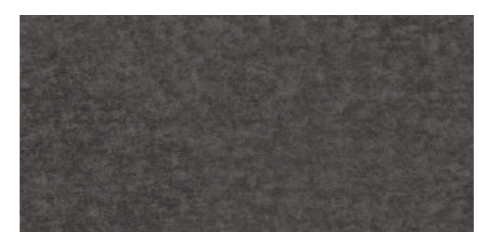

SAGA NERO



SAGA BIANCO

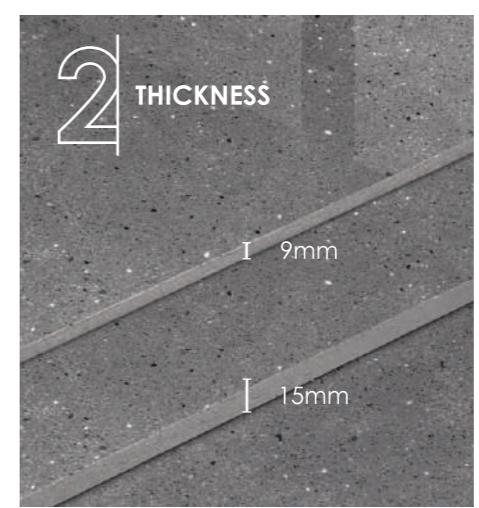



SAGA-EPOCALE COLLECTION

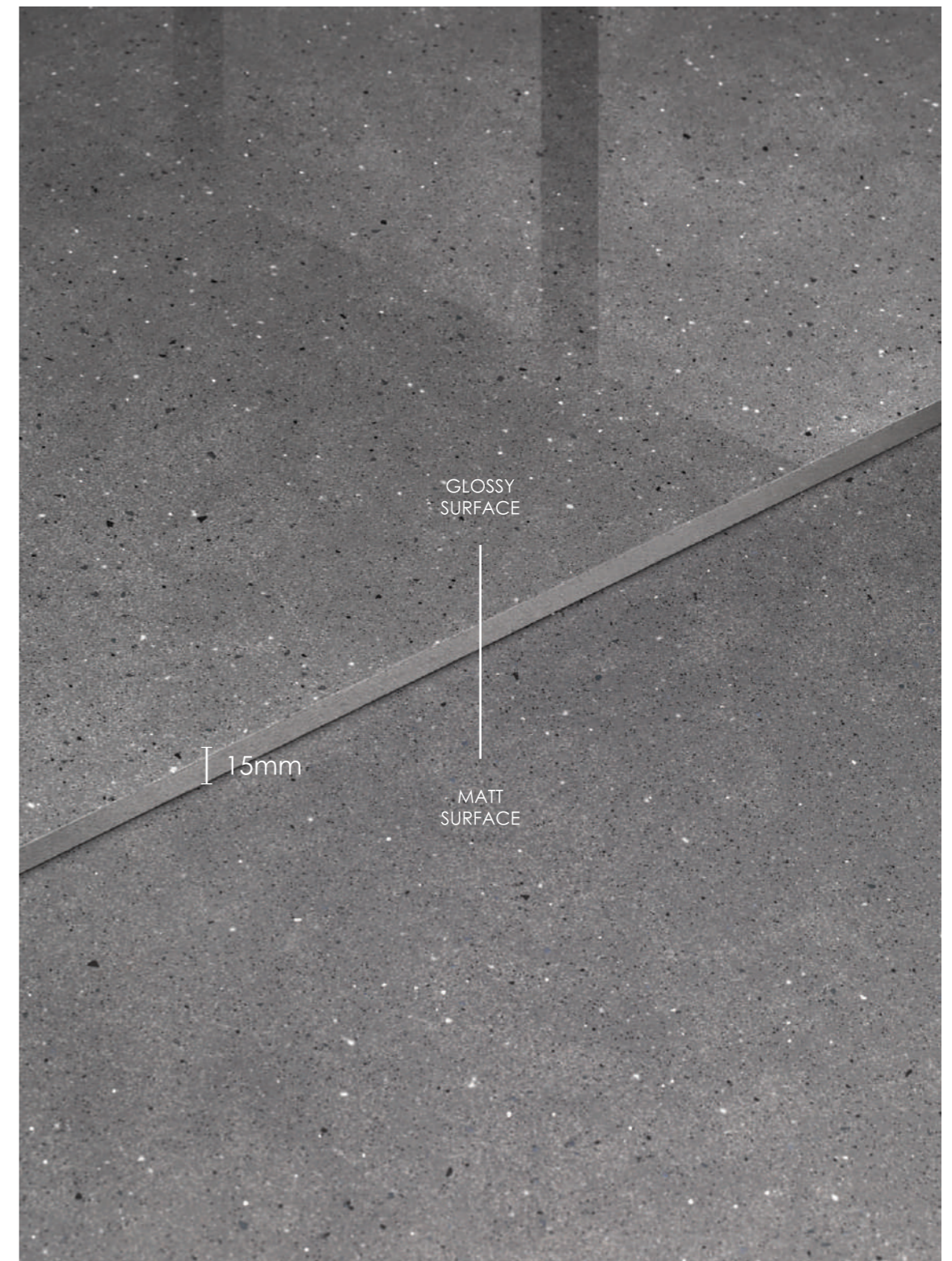

A sneak peek into our world class collection of Saga-Epocale tiles hand crafted for the clients who love uniqueness. Hues of cool colors that help you relaxed and refreshed. Dimensionally making smaller areas look largely spacious. Create the look worth cherishing. Let your dreams come true!

SAGA
GREY

SAGA-EPOCALE COLLECTION

Wall

SAGA WHITE

_Size: 120x240cm / 48x96in

_Surface: Glossy

Floor

SAGA GREY

_Size: 60x120cm / 24x48in

_Surface: Glossy



SAGA-EPOCALE COLLECTION

Wall

SAGA WHITE

_Size: 120x240cm / 48x96in

_Surface: Glossy

Floor 1

SAGA WHITE

_Size: 120x120cm / 48x48in

_Surface: Glossy

Floor 2

SAGA GREY

_Size: 60x120cm / 24x48in

_Surface: Glossy



Wall

SAGA GREY

_Size: 120x240cm / 48x96in

_Surface: Matt

Floor

SAGA NERO

_Size: 120x120cm / 48x48in

_Surface: Matt



SAGA-EPOCALE COLLECTION

Platform

SAGA NERO

_Size: 80x300cm / 32x120in

_Surface: Matt

Wall

SAGA GREY

_Size: 60x120cm / 24x48in

_Surface: Matt

Floor

SAGA GREY

_Size: 60x120cm / 24x48in

_Surface: Matt



SAGA WHITE



80x300cm / 32x120in 15mm



120x278cm / 48x110in 9mm



120x240cm / 48x96in 9mm

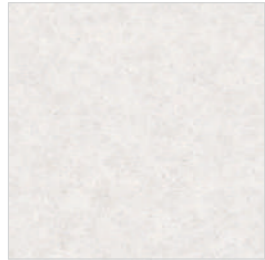

120x120cm / 48x48in 9mm



60x120cm / 24x48in 9mm

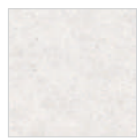

60x60cm / 24x24in 9mm

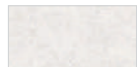

30x60cm / 12x24in 9mm

SAGA GREY



80x300cm / 32x120in 15mm



120x278cm / 48x110in 9mm



120x240cm / 48x96in 9mm



120x120cm / 48x48in 9mm



60x120cm / 24x48in 9mm



60x60cm / 24x24in 9mm



30x60cm / 12x24in 9mm

SAGA NERO



80x300cm / 32x120in 15mm



120x278cm / 48x110in 9mm



120x240cm / 48x96in 9mm

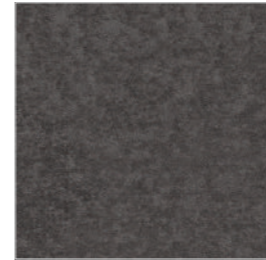

120x120cm / 48x48in 9mm



60x120cm / 24x48in 9mm

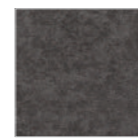

60x60cm / 24x24in 9mm



30x60cm / 12x24in 9mm

Thickness 9mm **Surface** Glossy / Matt

SAGA-EPOCALE COLLECTION



SAGA-EPOCALE COLLECTION

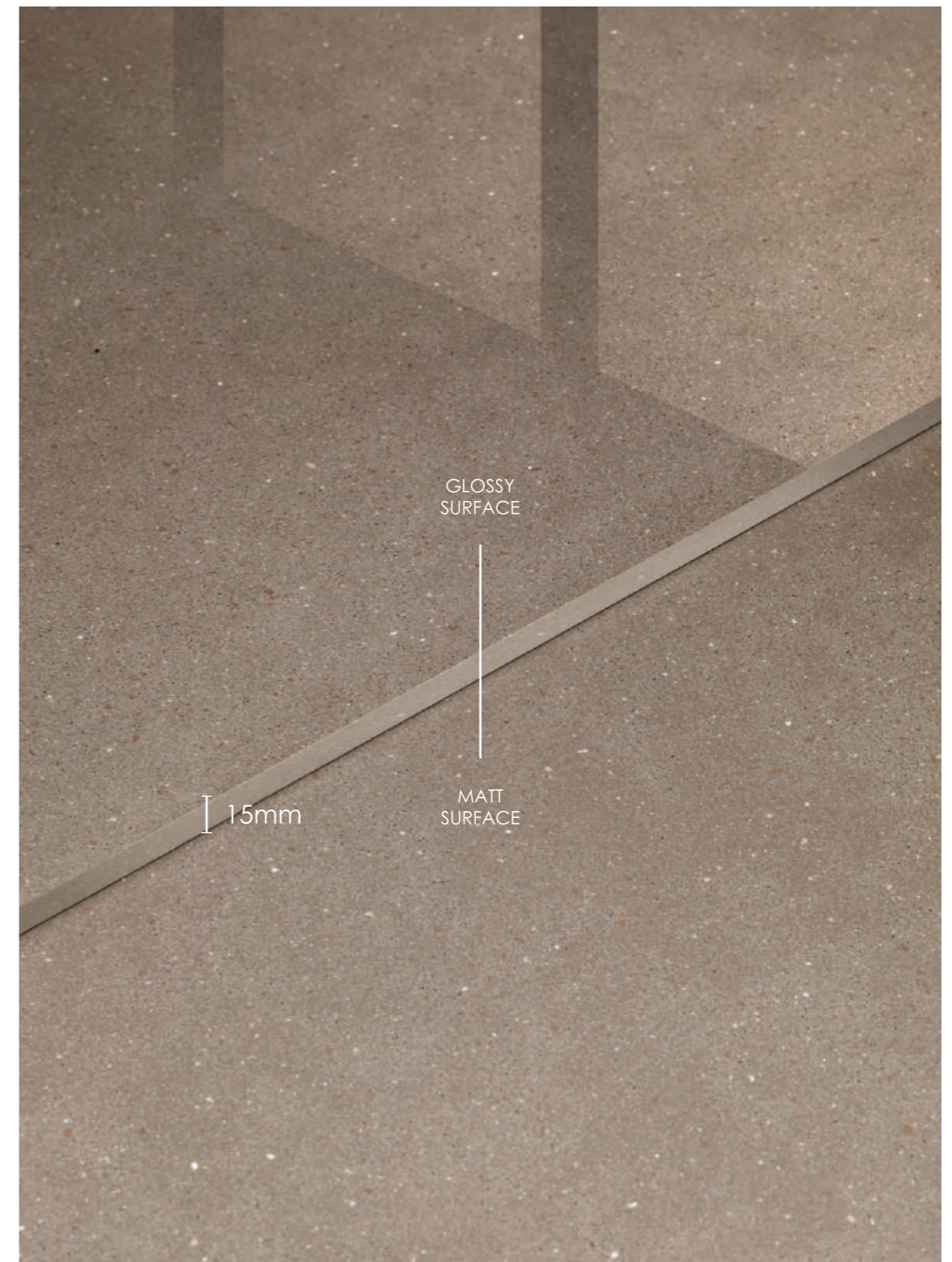

Decorate your spaces with natural looking designs and fine textures. Connect to a warmer color palette; generating vibes and ambience for a playful and cozy environment. Establishing living zones with an actively joyous feel. And visually putting together a life space that spells beauty. Come home to happiness.

SAGA
BIANCO

SAGA-EPOCALE COLLECTION

Wall

SAGA BIANCO

_Size: 30x60cm / 12x24in

_Surface: Matt + Glossy

Floor

SAGA BIANCO

_Size: 120x120cm / 48x48in

_Surface: Matt

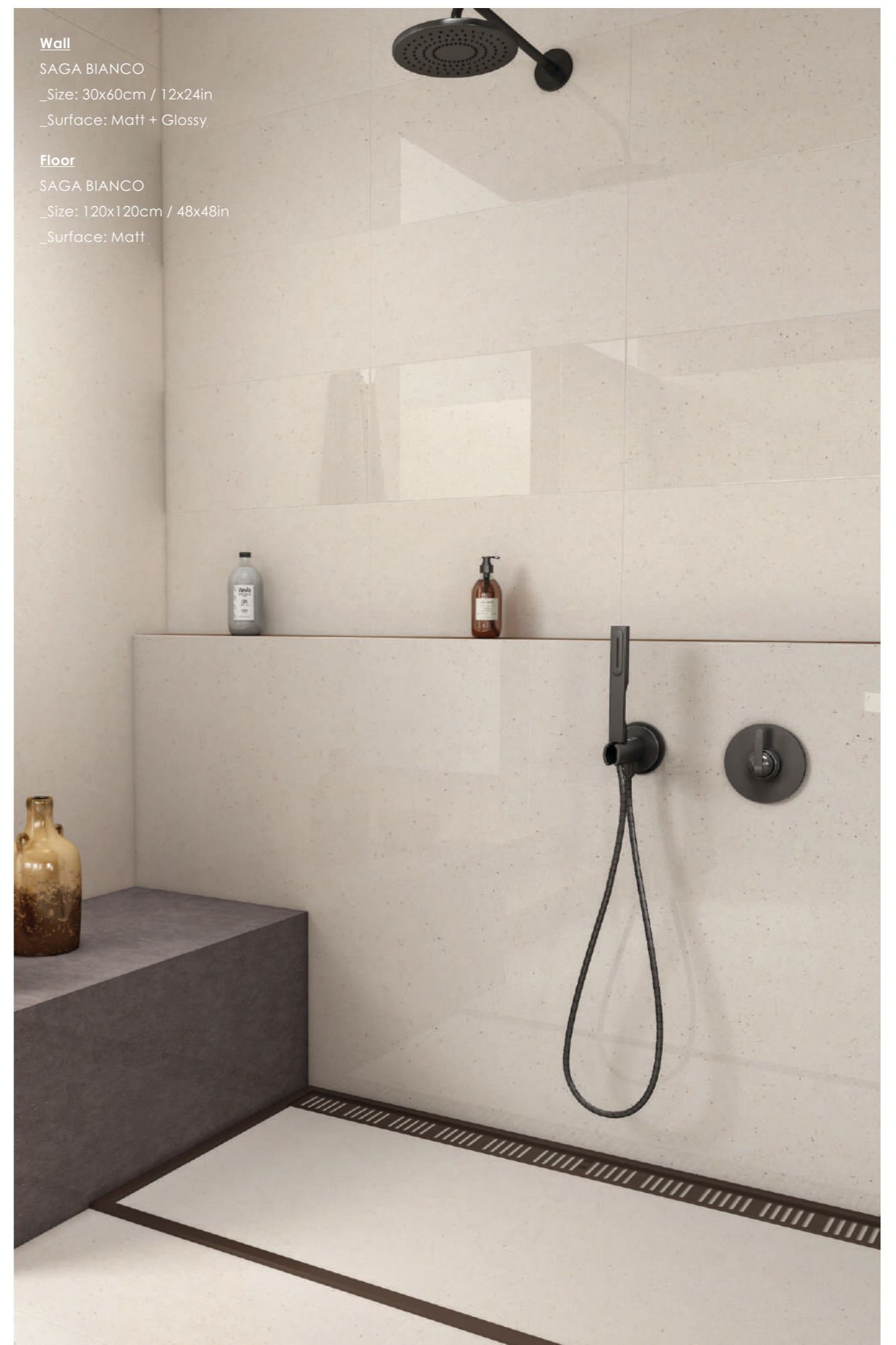

SAGA-EPOCALE COLLECTION

Wall 1

SAGA BIANCO
_Size: 120x240cm / 48x96in
_Surface: Glossy

Wall 2

SAGA BIANCO
_Size: 30x60cm / 12x24in
_Surface: Matt + Glossy

Floor

SAGA BIANCO
_Size: 120x120cm / 48x48in
_Surface: Matt



SAGA-EPOCALE COLLECTION

Wall

SAGA BARLEY

_Size: 30x60cm / 12x24in

_Size: 60x120cm / 24x48in

_Surface: Matt + Glossy

Floor

SAGA BARLEY

_Size: 120x120cm / 48x48in

_Surface: Matt



SAGA-EPOCALE COLLECTION

Wall 1

SAGA COCOA

_Size: 120x240cm / 48x96in

_Surface: Matt

Wall 2

SAGA BIANCO

_Size: 60x120cm / 24x48in

_Surface: Matt + Glossy

Floor

SAGA COCOA

_Size: 120x120cm / 48x48in

_Surface: Glossy



SAGA-EPOCALE COLLECTION

Platform

SAGA COCOA

_Size: 80x300cm / 32x120in

_Surface: Glossy

Floor

SAGA BARLEY

_Size: 120x120cm / 48x48in

_Surface: Matt

URBANE
TILE + STONE



SAGA BIANCO



80x300cm / 32x120in 15mm



120x278cm / 48x110in 9mm

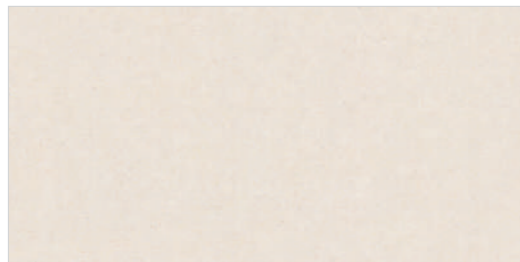

120x240cm / 48x96in 9mm

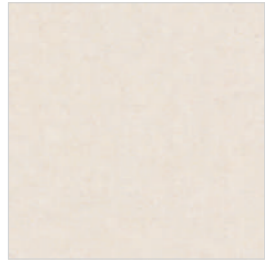

120x120cm / 48x48in 9mm

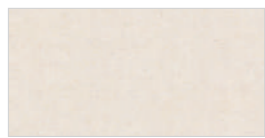

60x120cm / 24x48in 9mm

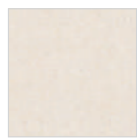

60x60cm / 24x24in 9mm



30x60cm / 12x24in 9mm

SAGA BARLEY



80x300cm / 32x120in 15mm



120x278cm / 48x110in 9mm

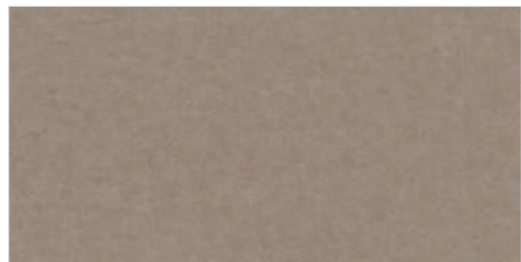

120x240cm / 48x96in 9mm



120x120cm / 48x48in 9mm



60x120cm / 24x48in 9mm



60x60cm / 24x24in 9mm

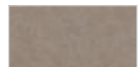

30x60cm / 12x24in 9mm

SAGA COCOA



80x300cm / 32x120in 15mm



120x278cm / 48x110in 9mm

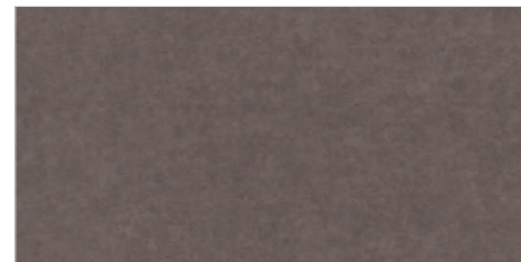

120x240cm / 48x96in 9mm



120x120cm / 48x48in 9mm



60x120cm / 24x48in 9mm



60x60cm / 24x24in 9mm



30x60cm / 12x24in 9mm

Thickness 9mm **Surface** Glossy / Matt

SAGA-EPOCALE COLLECTION

Cleaning & Maintenance

Our products are non porous (due to their high quality raw materials, stringent production parameters and state of the art technology), hence any dust or deposited waste cannot penetrate the surface.

For most cases only a damp cloth is sufficient for cleaning.

Regular cleaning highlights the aesthetic features of the surface and gives it exceptional shine.

For highly aggressive cleaning caused by some common food and substances follow the table below.

TYPE OF STAIN	CHEMICAL PRODUCT	EXAMPLE
Grease	Alkaline - Solvent	Detergent
Oil	Solvent	Ammonia, Baking Soda
Ink	Oxidant - Solvent	Alcohol, Liquid Bleach, Nail Paint Remover
Rust	Acid	Hydrochloric Acid, Vinegar, Red Harpic
Lime	Acid	Descaling Reagent, Hydro Chloric Acid
Cement	Acid	Hydro Chloric Acid
Wine	Alkaline	Ammonia, Liquid Bleach
Coffee	Alkaline - Solvent	Ammonia, Liquid Bleach
Rubber	Solvent	Alcohol, Thinner
Plaster	Acid	Hydro Chloric Acid
Candle Wax	Solvent	Alcohol, Thinner
Iodine	Oxidant	Liquid Bleach
Blood	Oxidant	Liquid Bleach
Ice Cream	Alkaline	Liquid Bleach

Note: It is recommended that any kind of stain needs to get clean immediately / as soon as possible.

Technical Specification

CHARACTERISTIC	STANDARD AS PER ISO13006:2018/ EN14411 Gr.BIa	STANDARD AS PER IS15622:2017 Gr.BIa	MEAN VALUE	TEST METHOD
Regulatory Properties				
Deviation in length and width	± 0.30 % (±1.00mm)	± 0.10 %	± 0.10 %	ISO 10545-2 & IS 13630-1
Deviation in thickness	± 5.00 % (±0.50mm)	± 5.00 %	± 4.00 %	ISO 10545-2 & IS 13630-1
Straightness in side	± 0.30 % (±0.80mm)	± 0.10 %	± 0.10 %	ISO 10545-2 & IS 13630-1
Rectangularity	± 0.30 % (±1.50mm)	± 0.10%	± 0.10 %	ISO 10545-2 & IS 13630-1
Surface flatness central curvature	± 0.40 % (±1.80mm)	± 0.50 %	± 0.20 %	ISO 10545-2 & IS 13630-1
Surface flatness edge curvature	± 0.40 % (±1.80mm)	± 0.50 %	± 0.20 %	ISO 10545-2 & IS 13630-1
Surface flatness warpage	± 0.40 % (±1.80mm)	± 0.50 %	± 0.10 %	ISO 10545-2 & IS 13630-1
Surface quality	> 95% defects free	> 95% defects free	> 95% defects free	ISO 10545-2 & IS 13630-1
Small color difference (for plain color)	ΔE < 0.75	N.A.	ΔE < 0.30	ISO 10545-16
Glossiness (with nano polished)	as per mfg.	as per mfg.	> 90**	Glossmeter 60°
Glossiness (without polished)	as per mfg.	as per mfg.	3° < GLOSS < 7°	Glossmeter 60°
Glossiness (satin)	as per mfg.	as per mfg.	7° < GLOSS < 18°	Glossmeter 60°
Structural Properties				
Water absorption	≤ 0.50 %	≤ 0.080 %	≤ 0.060 %	ISO 10545-3 & IS 13630-2
Bulk density	as per mfg.	Min. 2.20 g/cc	> 2.28 gm/cc	DIN51082 & IS 13630-2
Massive Mechanical Properties				
Modulus of rupture	Min. 35.0 N/mm ²	Min. 35.0 N/mm ²	Min. 40.0 N/mm ²	ISO 10545-4 & IS 13630-6
Breaking strength thickness <7.5	Min. 700.0 N	Min. 700.0 N	Min. 1000.0 N	ISO 10545-4 & IS 13630-6
Breaking strength thickness ≥7.5	Min. 1300.0 N	Min. 1300.0 N	Min. 1800.0 N	ISO 10545-4 & IS 13630-6
Breaking strength thickness ≥7.5(15mm)	Min. 1300.0 N	Min. 1300.0 N	Min. 5000.0 N	ISO 10545-4 & IS 13630-6
Surface Mechanical Properties				
MOH'S hardness	as per mfg.	Min. 5	Glossy - Min. 4 / Matt - Min. 6	BS EN 15771:2010
Deep abrasion resistance	Max. 175mm ³	Max. 140mm ³	Max. 132mm ³	ISO 10545-6 & IS 13630-12
Thermal Hydrometric Properties				
Moisture expansion	Max. 0.06%(0.6mm/m)	Max. 0.02mm/m	Max. 0.02mm/m	ISO 10545-10 & IS 13630-3
Thermal expansion(COE) at 100°C	as per mfg.	Max. 6.0 x 10 ⁻⁶	Max. 6.0 x 10 ⁻⁶	ISO 10545-8 & IS 13630-4
Thermal shock resistance	Min. 10 Cycle	Min. 10 Cycle	Min. 10 Cycle	ISO 10545-9 & IS 13630-5
Impact resistance(COR)	Min. 0.55	Min. 0.55	Min. 0.55	ISO 10545-5 & IS 13630-14
Frost resistance	as per mfg.	as per mfg.	Frost Proof	ISO 10545-12 & IS 13630-10
Chemical Properties				
Resistance to staining glazed	Min. Class 3	Min. Class 2	Min. Class 4/Min. Class 2	ISO 10545-14 & IS 13630-8
Resistance to household chemicals & swimming pool salts glazed	Min. Class UB	as per mfg.	Min. Class UB/Min. Class A	ISO 10545-13 & IS 13630-8
Resistance to low concentrate acid and alkalis glazed	as per mfg.	as per mfg.	Min. Class ULB*/Min. Class A***	ISO 10545-13 & IS 13630-8
Resistance to high concentrate acid and alkalis glazed	as per mfg.	as per mfg.	Min. Class UHB*/Min. Class A***	ISO 10545-13 & IS 13630-8
Safety Properties				
Skid resistance(DCOF-DRY)##	as per mfg.	as per mfg.	Polished - < 0.30 / Matt - > 0.40	ANSI/NFSI B101.3-2012
Slip resistance(DCOF)(R value)##	as per mfg.	as per mfg.	R9 to R13	DIN 51130
Fire resistance	as per mfg.	N.A.	Fire Proof	N.A.

* Glossiness 90% with nano technology
 ** Except Hydrofluoric Acid & it's compound
 # Unglazed tiles Intended for use on floor
 ## As per customer requirement

Packing Details

PRODUCT	SIZE	ACTULE SIZE	SIZE IN INCH	THICKNESS	TILES / BOX	COVERAGE AREA / BOX
SAGA-EPOCALE	80x300cm	800x3000mm	32x120in	15mm	1pc	25.83 Sq ft 2.40 Sq m
	120x278cm	1200x2780mm	48x110in	9mm	1pc	35.91 Sq ft 3.34 Sq m
	120x240cm	1200x2400mm	48x96in	9mm	1pc	31.00 Sq ft 2.88 Sq m
	120x120cm	1200x1200mm	48x48in	9mm	2pcs	31.00 Sq ft 2.88 Sq m
	60x120cm	598x1198mm	24x48in	9mm	2pcs	15.38 Sq ft 1.43 Sq m
	60x60cm	598x598mm	24x24in	9mm	4pcs	15.38 Sq ft 1.43 Sq m
	30x60cm	298x598mm	12x24in	9mm	6pcs	11.50 Sq ft 1.07 Sq m

URBANE TILE & STONE

Plot No.4, Shivam Estate,
Rafaleshwar Road,
At. Jodhpar (Nadi),
Morbi - 363 641. Gujarat. INDIA.

Contact: +91 75679 25522

e-mail: export@urbane.global

web: www.urbane.global